

| CONSTRUCTION OPTIONS                              | CODE  |
|---|---|
| All Plywood Construction Option                   | APC   |
| Cabinet Front Only Option                         | CFO   |
| CushionClose® Package                             | (Pre-selected in 20-20)   |
| Furniture Ends Option                             | FE  |
| Increased Depth Cabinet Option                    | ID  |
| Inverted Frame Cabinet Option                     | IF  |
| Matching Interior Cabinet Option                  | MI  |
| Plywood Ends Option                               | PE  |
| Premium Finish Cabinet Options                    | Maple Auburn Glaze<br>Maple Mocha Glaze<br>Painted Boulder<br>Painted Cashmere<br>Painted Ember Glaze<br>Painted Harbor<br>Painted Hazelnut Glaze<br>Painted Linen<br>Painted Pewter Glaze<br>Painted Silk<br>Painted Stone |
| Recessed Toe Kick Option                          | RTKL (Recessed Toe Kick Left)<br>RTKR (Recessed Toe Kick Right)<br>RTKB (Recessed Toe Kick Both)  |
| Reduced Depth Cabinet Option                      | RD  |
| Void Door Wall Cabinet Option - NO Molding        | VDO-DFH (Drilled For Hinges)  |
| Void Door Wall Cabinet Options –INCLUDING Molding | VDO-SAM (Shaker Accent Molding)<br>VDO-SBAM (Single Bead Accent Molding)<br>VDO-TBAM (Triple Bead Accent Molding)   |
| Remove CushionClose for Doors                     | XCDO  |
| Remove CushionClose for Drawers                   | XCDW  |
| Remove CushionClose for Roll Out Accessories      | XCRO  |

| SPECIALTY DOOR (SD) OPTIONS            | CODE |
|--|------|
| Aluminum Frame Door - Brushed Aluminum | AFBA |
| Aluminum Frame Door - Vintage Iron     | AFVI |
| Horizontal Frame Door                  | HFD  |
| Mullion Frame Door                     | MFD  |
| Open Frame Door                        | OFD  |
| Prairie Frame Door                     | PFD  |

1. When the option appears, it indicates the construction option is available for all SKU's in the product box unless otherwise noted.

In this product box, all SKUs (B36, B39, B42 and B48) are available with All Plywood Construction Cabinet Front Only, Furniture Ends Inverted Frame Cabinet, Plywood Ends Reduced Depth Cabinet and Recessed Toe Kick options.

**Base Cabinet**  
2 Doors, 2 Drawers

|     |     |
|-----|-----|
| B36 | APC |
| B39 | CFO |
| B42 | FE  |
| B48 | IF  |
|     | PE  |
|     | RD  |
|     | RTK |

2. When a square ■ is included within the icon and next to the SKU, it indicates the construction option is ONLY available for that specific SKU.

In this product box, only the W930, W1230, W1530, W1830, W2130 and W2430 are available with the Void Door or Matching Interior Options as the Specialty Door (SD) cabinets feature Matching Interior standard.

**Wall Cabinet**  
30" High, 1 Door

|         |       |
|---------|-------|
| ■ W930  | APC   |
| ■ W1230 | CFO   |
| ■ W1530 | FE    |
| ■ W1830 | ID    |
| ■ W2130 | ■ MI  |
| ■ W2430 | PE    |
|         | RD    |
|         | ■ VDO |

W1230 SD  
W1530 SD  
W1830 SD  
W2130 SD

3. When a construction icon is not listed, it indicates the construction option is NOT available for any SKU in the product box.

In this product box, none of the SKUs are available with Matching Interior or Void Door Options as these icons are not listed.

**Base Cabinet**  
1 Door, 1 Drawer

|     |     |
|-----|-----|
| B12 | APC |
| B15 | CFO |
| B18 | FE  |
| B21 | IF  |
| B24 | PE  |
|     | RD  |
|     | RTK |

## All Plywood Construction Option

APC

All Plywood Construction Option includes:

- ½" plywood sides, floors and cabinet tops
- ¾" plywood shelves with edge banding
- ⅛" plywood captured back
- ½" plywood inset toe kick
- ½" plywood corner blocks (excluding BEA/BER/BPP/BPPUS/BTDP/BSS/CAR/CBS/CSB cabinets)

## Notes:

- Exterior sides finished to match specific cabinet box exterior.
- Plywood will be visible from top and bottom of side panels.
- Available for individual cabinets or entire kitchen.
- Available for all door styles.
- All door styles feature standard interior sides of natural woodgrain finish.
- **Cannot be ordered with Plywood Ends Option.**
- Available with Matching Interior Option. Please refer to the product SKU box for details  MI .
- Toe kick support blocks are not plywood.
- Roll out accessories and drawer inserts will not feature All Plywood Construction.
- All Plywood Construction refers to the cabinet box components and shelving as detailed above (certain parts and accessories are not available with this construction option).
- Plywood can consist of a combination of veneer and medium density fiberboard (MDF) layers to achieve superior product stability and finish quality. Plywood components meet the ANSI/Decorative Hardwoods Association hardwood and decorative plywood standards ([www.decorativehardwoods.org](http://www.decorativehardwoods.org)).

## Plywood Ends Option

PE

Plywood Ends Option includes:

- ½" plywood cabinet sides

## Notes:

- Exterior sides finished to match specific cabinet box exterior.
- Plywood will be visible from top and bottom of side panels.
- Available for individual cabinets or entire kitchen.
- All door styles feature standard interior sides of natural woodgrain finish.
- **Cannot be ordered with All Plywood Construction Option or Furniture Ends Option.**
- Available with Matching Interior Cabinet Option. Please refer to the product SKU box for details  MI .
- Plywood Ends refers to the cabinet box side panels as detailed above (certain parts and accessories are not available with this construction option).
- Plywood can consist of a combination of veneer and medium density fiberboard (MDF) layers to achieve superior product stability and finish quality. Plywood components meet the ANSI/Decorative Hardwoods Association hardwood and decorative plywood standards ([www.decorativehardwoods.org](http://www.decorativehardwoods.org)).

## Cabinet Front Only Option

CFO

The Cabinet Front Only Option is available for most cabinets with a frame (see individual cabinet specifications for  CFO  icon verifying this option availability).

## Notes:

- This option consists of the cabinet front face frame, door(s), drawer front(s) and hinges.
- Toe kicks are not included.
- This option is only available for cabinets without accessories.

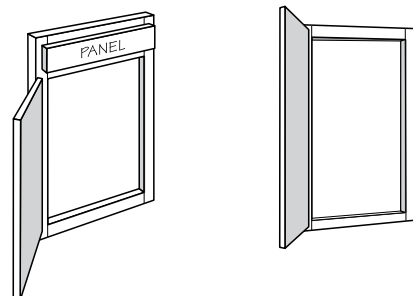

|  | Standard Construction                                  | Plywood Ends Option (PE)  | All Plywood Construction Option (APC)          |
|--|--|---|--|
| <b>Cabinet Sides</b>   | ½" Engineered Wood with TuffTech finish                | ½" Plywood Exterior   | ½" Plywood Exterior                            |
| <b>Cabinet Floor</b>   | ½" Engineered Wood                                     | ½" Engineered Wood  | ½" Plywood                                     |
| <b>Cabinet Top (Wall Cabinets Only)</b>  | ½" Engineered Wood                                     | ½" Engineered Wood  | ½" Plywood                                     |
| <b>Cabinet Back</b>  | ⅛" Hardboard Substrate captured                        | ⅛" Hardboard Substrate captured   | ⅛" Plywood captured                            |
| <b>Face Frame</b>  | Double-Doweled ¾" x 1 ⅝" Hardwood                      | Double-Doweled ¾" x 1 ⅝" Hardwood   | Double-Doweled ¾" x 1 ⅝" Hardwood              |
| <b>Inset Toe Kick</b>  | ½" Engineered Wood                                     | ½" Engineered Wood  | ½" Plywood                                     |
| <b>Corner Blocks (excluding BER/BSS/CAR/CBS/CSB cabinets)</b>  | ½" Engineered Wood                                     | ½" Engineered Wood  | ½" Plywood                                     |
| <b>Shelves</b>   | ¾" Engineered Wood with Edge Banding                   | ¾" Engineered Wood with Edge Banding  | ¾" Plywood with Edge Banding                   |
| <b>Wall Cabinet Hanging Rails</b>  | ½" Engineered Wood Top and Bottom Rails                | ½" Engineered Wood Top and Bottom Rails   | ½" Plywood Top and Bottom Rails                |
| <b>Base Cabinet Hanging Rails</b>  | ¾" Hardwood Top Rail<br>½" Engineered Wood Bottom Rail | ¾" Hardwood Top Rail<br>½" Engineered Wood Bottom Rail  | ¾" Hardwood Top Rail<br>½" Plywood Bottom Rail |
| <b>Standard Interior</b>   | Natural Woodgrain TuffTech                             | Natural Woodgrain TuffTech Tops, Bottoms, Shelves and Back with Natural Woodgrain Side Panels                   | Natural Woodgrain                              |
| <b>Specialty Door cabinets or cabinets that feature Matching Interior Cabinet Option (N/A Maple Natural)</b> | TuffTech Finish  | TuffTech Finish Tops, Bottoms, Shelves and Back with Plywood Side Panels finished to match cabinet box exterior | Plywood finished to match cabinet box exterior |

## Inverted Frame Cabinet Option

IF

The Inverted Frame Cabinet Option is available for most Standard Base Cabinets, Base Cabinets with Factory Installed Wastebasket(s) and Base Pot & Pan Organizer Cabinets (see individual cabinet specifications for  IF  icon verifying this option availability).

## Notes:

- Drawer(s) below full cabinet floor.
- Available with All Plywood Construction (APC), Furniture Ends (FE), Plywood Ends (PE), Reduced Depth (RD) and Recessed Toe Kick (RTK) options.
- Back is not predrilled for Deep Roll Out Trays (DROT's).

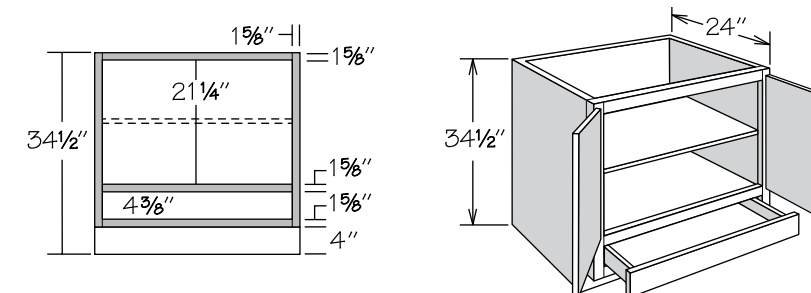

## Furniture Ends Option

FE

Furniture Ends Option includes:

- 3/4" plywood cabinet sides

### Notes:

- Exterior sides feature plywood finished to match specific cabinet box exterior.
- Plywood will be visible from top and bottom of side panels.
- Available on individual cabinets except BEA24 FH Base End Angle and WEA12 Wall End Angle cabinets.
- When the Furniture Ends Option is selected, both side panels convert to 3/4" plywood sides except BEA12 FH Base End Angle cabinet which converts the 12" side panel only.
- Available for all door styles.
- All door styles feature standard interior sides of natural woodgrain finish with plywood exterior.
- May be combined with standard construction, All Plywood Construction and all other construction options except the Plywood Ends Option.
- End panels are not required for exposed ends of cabinets with the Furniture Ends Option.
- End panels are not required for installation of Decorator Matching Doors to cabinets with the Furniture Ends Option.
- Cabinet Angle Molding (CAM8) cannot be used with cabinets with the Furniture Ends Option.
- Sink Front Return (SFR R/L) with the Furniture Ends Option will include a rabbeted front edge.
- A seam will be visible between stacked cabinets and on 93" and 96" Tall cabinets between the toe kick box and the cabinet. Recommendations to conceal this seam:
  - Use decorative molding (e.g., BM8 WD Batten Molding or OGP8 Ogee Pilaster Molding)
  - Use a Column Filler or Wood Tall End Panel
- Cannot be ordered with Plywood Ends Option.
- Plywood can consist of a combination of veneer and MDF layers to achieve superior product stability and finish quality. Plywood components meet the ANSI/Decorative Hardwoods Association hardwood and decorative plywood standards ([www.decorativehardwoodsassociation.org](http://www.decorativehardwoodsassociation.org)).

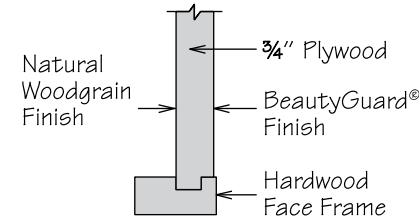

## Void Door Cabinet Option

VDO

The Void Door Cabinet Option is available for most wall cabinets. All void door cabinets ship without doors or hinges – center stiles and adjustable shelves will remain. Cabinet frames are pre-drilled for door hinges. All void door wall top hinge cabinets ship without door, lid stays and hinges.

Refer to the descriptions below to select the correct option for your layout:

- VDO-DFH (Drilled For Hinges)
- VDO-SBAM (Single Bead Accent Molding)
- VDO-TBAM (Triple Bead Accent Molding)
- VDO-SAM (Shaker Accent Molding)

### Notes for VDO with Molding:

- Can be used to create decorative open cabinets
- Decorative Accent Moldings will conceal hinge holes
- Molding is to be cut and field installed at the job site
- When matching interior is desired, the Matching Interior Cabinet Option must be selected

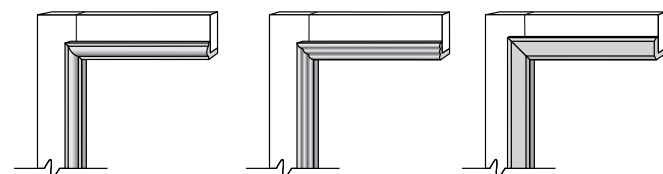

**VDO-SBAM**  
Single Bead Accent Molding

**VDO-TBAM**  
Triple Bead Accent Molding

**VDO-SAM**  
Shaker Accent Molding

## Premium Finish Cabinet Option

Our premium finishes accentuate the detailing and textures of the cabinetry.

Options include:

- Luxurious paint that emphasizes lines and rich detail with an inviting texture.
- Glazes that settle into the recesses, corners and grooves to add definition and a distinctive patina.
- Glazes are applied over either a wood stain or painted base.

| Premium Finish                | Base Finish Details | Glaze Details   | Available Collections  |
|-------------------------------|---------------------|-----------------|--|
| <b>Maple Auburn Glaze</b>     | Maple Cognac        | Dark Brown      | All Maple door styles, excluding Del Ray, Hanover, Leesburg, Leesburg w/ DFO, Reading and Reading w/ DFO |
| <b>Maple Mocha Glaze</b>      | Maple Spice         | Dark Brown      | All Maple door styles, excluding Del Ray, Hanover, Leesburg, Leesburg w/ DFO, Reading and Reading w/ DFO |
| <b>Painted Ember Glaze</b>    | Painted Harbor      | Warm Brown Gray | Ashland, Brookland, Charlottesville, MacArthur, Newport, Olmsted, Portola, Portola w/ DFO and Savannah   |
| <b>Painted Hazelnut Glaze</b> | Painted Silk        | Deep Brown      | Ashland, Brookland, Charlottesville, MacArthur, Newport, Olmsted, Portola, Portola w/ DFO and Savannah   |
| <b>Painted Pewter Glaze</b>   | Painted Linen       | Dark Gray       | Ashland, Brookland, Charlottesville, MacArthur, Newport, Olmsted, Portola, Portola w/ DFO and Savannah   |

| Premium Finish          | Finish Details         | Available Collections   |
|-------------------------|------------------------|---|
| <b>Painted Boulder</b>  | Dark Gray Paint        | Ashland, Brookland, Charlottesville, Del Ray, Leesburg, Leesburg w/ DFO, MacArthur, Newport, Olmsted, Portola, Portola w/ DFO, Reading, Reading w/ DFO, Savannah and Shorebrook |
| <b>Painted Cashmere</b> | Creamy Taupe Paint     | Ashland, Brookland, Charlottesville, Del Ray, Leesburg, Leesburg w/ DFO, MacArthur, Newport, Olmsted, Portola, Portola w/ DFO, Reading, Reading w/ DFO, Savannah and Shorebrook |
| <b>Painted Harbor</b>   | Soft Warm Gray Paint   | Ashland, Brookland, Charlottesville, Del Ray, Leesburg, Leesburg w/ DFO, MacArthur, Newport, Olmsted, Portola, Portola w/ DFO, Reading, Reading w/ DFO, Savannah and Shorebrook |
| <b>Painted Linen</b>    | Soft White Paint       | Ashland, Brookland, Charlottesville, Del Ray, Leesburg, Leesburg w/ DFO, MacArthur, Newport, Olmsted, Portola, Portola w/ DFO, Reading, Reading w/ DFO, Savannah and Shorebrook |
| <b>Painted Silk</b>     | Soft Cream Paint       | Ashland, Brookland, Charlottesville, Del Ray, Leesburg, Leesburg w/ DFO, MacArthur, Newport, Olmsted, Portola, Portola w/ DFO, Reading, Reading w/ DFO, Savannah and Shorebrook |
| <b>Painted Stone</b>    | Medium Cool Gray Paint | Ashland, Brookland, Charlottesville, Del Ray, Leesburg, Leesburg w/ DFO, MacArthur, Newport, Olmsted, Portola, Portola w/ DFO, Reading, Reading w/ DFO, Savannah and Shorebrook |

## Reduced Depth Cabinet Option

RD

The Reduced Depth Cabinet Option should be used when ordering less than standard depth cabinets. Reduced Depth cabinets are available in 1" reductions; minimum cabinet depth is 4". Vanity and Desk cabinets will reduce to standard Reduced Depth increments (i.e. Vanity cabinets with RD-20 will measure 20" in depth).

Orders specifying Reduced Depth Option must show the total cabinet depth.

Example: Cabinet: B24  
Option: RD-17 (RD – Reduce to 17" Deep)

### Notes:

- There is a potential tipping hazard for Reduced Depth Cabinets until they are mounted to a wall.
- Peninsula Base cabinets reduced to 11" or less will not have an inset toe kick.
- Adjustable shelves are reduced in 1" increments to match Reduced Depth Option selected on cabinet(s).
- Adding the Reduced Depth Cabinet Option does not remove adjustable shelves (where applicable).
- All cabinets reduced to 5" or less will not have an inset toe kick.
- All cabinets reduced to 8" or less are not available with the Recessed Toe Kick Option.
- Reduced depth minimum for Wall Top Hinge cabinets is 8".
- Reduced depth minimum for Base End Angle (BEA12FH) cabinets is 18".
- Reduced depth minimum for Kneehole Drawer cabinets is 12".
- Reduced depth minimum for Two Drawer Base cabinets is 21".
- Reduced depth minimum for 24" Deep Furniture Drawer cabinets is 13".

| Reduced Depth | Drawer Depth Base & 24" Deep Desk Cabinets | Drawer Depth Vanity & 21" Deep Desk Cabinets | Deep Roll Out Tray Depth |
|---------------|--|--|--------------------------|
| RD-23         | 18"  | —  | 18"                      |
| RD-22         | 18"  | —  | 18"                      |
| RD-21         | 18"  | —  | 18"                      |
| RD-20         | 15"  | 15"  | 15"                      |
| RD-19         | 15"  | 15"  | 15"                      |
| RD-18         | 15"  | 15"  | 15"                      |
| RD-17         | 12"  | 12"  | 12"                      |
| RD-16         | 12"  | 12"  | 12"                      |
| RD-15         | 12"  | 12"  | 12"                      |
| RD-14         | 9"   | 9"   | 9"                       |
| RD-13         | 9"   | 9"   | 9"                       |
| RD-12         | 9"   | 9"   | 9"                       |
| RD-11 to RD-4 | No Drawer                                  | No Drawer                                    | Not Available            |

## Increased Depth Cabinet Option

ID

The Increased Depth Cabinet Option is available for most Wall cabinets up to 36" wide (refer to individual cabinet specifications for  ID icon verifying this option availability) and all Bookshelves available in 1" increments. Maximum cabinet depth is 24".

Orders specifying Increased Depth Option must show the total cabinet depth.

Example: Cabinet: W1530  
Option: ID-14 (ID – Increase to 14" Deep)

### Notes:

#### Wall Cabinets:

- Adjustable shelves are increased in 1" increments to match Increased Depth Option selected on cabinets.
- Increased Depth Wall cabinets up to and including 18" deep can be mounted using standard installation procedures.
- Wall cabinets increased to more than 18" deep must be stacked, floor mounted or installed over a refrigerator.
- All Increased Depth cabinets must be securely attached in one of the following combinations: to studs in back wall and both sides OR to studs in back wall, one side and top (e.g., two adjacent cabinets or one adjacent cabinet and a wall).

#### Peninsula Wall (PW) and Blind Peninsula Wall (BLPW) Cabinets:

- Increased Depth PW and BLPW cabinets up to 15" deep may be mounted at ceiling height using standard installation procedures.
- PW and BLPW cabinets increased to more than 15" deep must be stacked or floor mounted.
- When mounting cabinet at ceiling height, the cabinet must be securely attached to the ceiling rafters and to at least one other properly mounted cabinet or studs in wall.
- Additional 2" x 4" bracing may be required above ceiling if cabinets are not located directly below a rafter.
- Mount cabinet to the ceiling using mounting screws of sufficient length to go through ceiling treatment and into the rafter at least 1". Screws must be installed at both front and back of cabinet on 16" centers (maximum span), with at least four screws per cabinet.

## Recessed Toe Kick Option

RTK

The Recessed Toe Kick Option is available on most Base, Desk and Vanity base cabinetry (refer to individual cabinet specifications for  RTK verifying this option availability). When the Recessed Toe Kick Option is selected, left, right or both must be specified.

### Notes:

- Recommended for cabinets at the end of a run, especially in island and peninsula designs.
- Recessed side(s) are constructed of 1/2" thick unfinished plywood and are recessed 3 1/2" to match front of cabinet.
- **Recessed Toe Kick box is not flush on non-recessed side.**
- Blind Corner Base cabinets (BLB\_) are only available with the Recessed Toe Kick Both Option (RTKB).
- BEA24 FH and BEA12 FH Base End Angle, BPP9 Base Pantry Pull Out, BPPUS9 Base Pantry Pull Out Utensil Storage, BTDP9 Base Tray Divider Pull Out, TB9 and TB9 TDS cabinets are not available with the Recessed Toe Kick Both Option (RTKB).
- Not available for cabinets with the Reduced Depth Cabinet Option of RD-8 and lower.
- Not available for Peninsula Base cabinets with the Reduced Depth Cabinet Option of RD-11 and lower.
- For Peninsula Base cabinets, the drawer side indicates the front of the cabinet.
- Peninsula Base cabinets ordered with Recessed Toe Kick Option must be secured to the floor through the cabinet bottom into bracing secured to the floor.
- Base Toe Kick (BTK8) required for front and any exposed side(s).

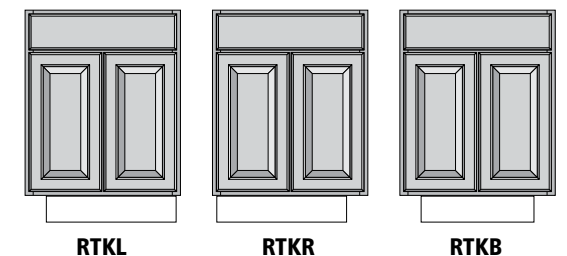

## CushionClose Package

The CushionClose package includes CushionClose for Drawers (including full-height pull outs), CushionClose for Doors and CushionClose for Roll Out Accessories and is pre-selected in 20-20.

### Notes:

- CushionClose for Drawers and CushionClose for Roll Out Accessories provide all of the features and benefits of the standard Full-Access Hidden Glides System with the addition of an integrated slow-close mechanism that reduces slamming and noise.
- CushionClose for Doors features a slow closing mechanism that helps reduce slams and noise.
- Decorative hardware strongly recommended.
- CushionClose is not available for BER\_, BSDC6, BSS\_, CAR\_, MC\_, TV\_30, WER\_ and WTH\_.

## Remove CushionClose for Doors

XCDO

The Remove CushionClose for Doors option is available for most cabinets with a door.

### Notes:

- This option removes CushionClose for Doors.

## Remove CushionClose for Drawers

XCDW

The Remove CushionClose for Drawers option is available for all cabinets with a drawer.

### Notes:

- Removes CushionClose for Drawers and replaces glides with Full-Access Hidden Glides.
- Wastebasket cabinets will be replaced with heavy-duty non-CushionClose glides.
- CushionClose cannot be removed from 2 Drawer Base cabinets.

## Remove CushionClose Roll Out Accessories

XCRO

The Remove CushionClose for Roll Out Accessories is available for most cabinets.

### Notes:

- This option removes CushionClose from Roll Out Accessories and replaces glides with side-mounted glides.

## Matching Interior Cabinet Option

MI

The Matching Interior Cabinet Option is available for Wall cabinets (with exceptions noted below), Utility cabinets, Vanity Linen cabinets and Refrigerator Return Panels. This option matches the cabinet's interior, top and bottom to that of the cabinet box exterior. For textured-wrapped Duraform, refer to door style page for box finish.

### Notes:

- Available for Wall, Utility and Vanity Linen cabinets with the All Plywood Construction Option (APC), Plywood Ends Option (PE), Furniture Ends Option (FE), Reduced Depth Cabinet Option (RD), Increased Depth Cabinet Option (ID) or standard construction.
- American Woodmark strongly recommends using the All Plywood Construction Option (APC) when Matching Interior (MI) is selected.
- Standard construction cabinetry with the Matching Interior Cabinet Option features two-sided engineered wood side panels with TuffTech finished to match cabinet box exterior.
- Cabinetry with the All Plywood Construction Option (APC), Furniture Ends Option (FE) or Plywood Ends Option (PE) features plywood side panels finished to match cabinet box exterior.
- Matching Interior cabinetry with the All Plywood Construction Option features  $\frac{3}{4}$ " plywood shelves finished to match cabinet box exterior.
- Recommended for cabinets with the Void Door Cabinet Option (VDO).
- Not available for any Wall cabinet with a standard Matching Interior (i.e. Specialty Door cabinets, Bookshelves, Microwave Cabinets, etc.).
- All finished surfaces of the Wall, Utility and Vanity Linen cabinets will be color matched including shelves, back, interior and exterior of returns, top and bottom, Corner Wall back post and back side of Peninsula Wall face frames.
- Interior accessories in Matching Interior cabinets (i.e., Spice Rack Kit, Deep Roll Out Trays, Pantry Swing Out Kit) will remain natural finish.

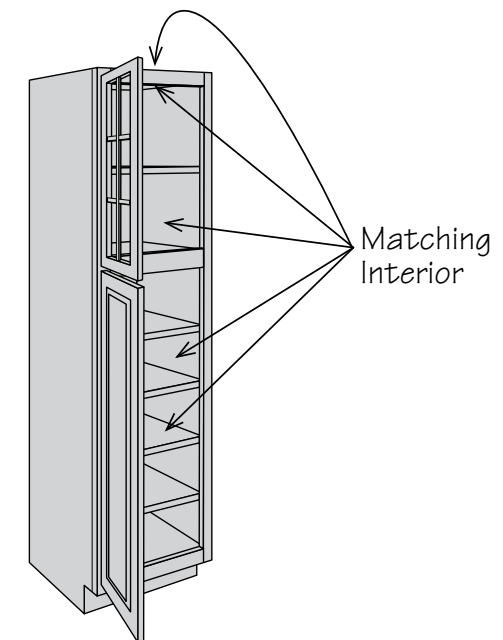
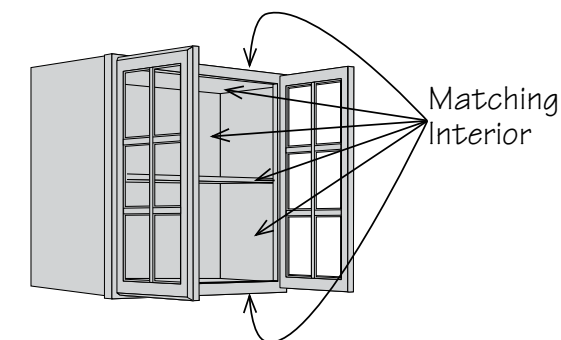

## Specialty Door Options

Specialty Door cabinets are available for most Wall, Utility and Vanity Linen cabinet sizes. All Specialty Door cabinets include Matching Interior as standard (see page 61 for Matching Interior option) and require one of the specialty door options below. Specialty Door options for Utility and Vanity Linen cabinets apply to top door(s) only.

### Open Frame Door (OFD) notes:

- Features door frame only with no mullions or center panel.
- Decorative Glass Inserts and appropriate glass clips are shipped separately from the cabinet for field installation - see pages 70-72 for available Glass Inserts.
- See page 64 for door style profiles.

### Mullion Frame Door (MFD) notes:

- Features grid-style mullions.
- Not available for Wall Top Hinge cabinets.
- Decorative Glass Inserts and appropriate glass clips are shipped separately from the cabinet for field installation - see pages 70-72 for available Glass Inserts.
- See pages 65-67 for door style profiles.

### Horizontal Frame Door (HFD) notes:

- Features horizontal mullions.
- Not available for Wall Top Hinge cabinets.
- Not available for 12" high cabinets.
- Decorative Glass Inserts and appropriate glass clips are shipped separately from the cabinet for field installation - see pages 70-72 for available Glass Inserts.
- See page 68 for door style profiles.

### Prairie Frame Door (PFD) notes:

- Craftsman-inspired mullions featuring 9 lites for all available door sizes.
- Corner lites will be a 1½" square for all available door sizes.
- Not available for Wall Top Hinge cabinets.
- 12" High Specialty Door cabinets (SD) with the Prairie Frame Door Option (PFD) only available for Leesburg, Leesburg w/ DFO, or Shorebrook (excluding Duraform) door styles.
- Decorative Glass Inserts and appropriate glass clips are shipped separately from the cabinet for field installation - see pages 70-72 for available Glass Inserts.
- See page 67 for door style profiles.

### Aluminum Frame Door (AFBA/AFVI) notes:

- Available for Full Overlay door styles only.
- Cathedral door styles default to square.
- Door stiles and rails are 2 1/8" mitered aluminum with Brushed Aluminum (AFBA) or Vintage Iron (AFVI) finish.
- Glass panels are factory installed and non-removable - see page 69 for frame and glass combinations.
- Glass panels are tempered for safety with etched finish.

## Specialty Door Availability by Size

| Door Width | Cabinet Door Height |               |               |               |               |               |               |               |               |               |                                  |                  |                  |                  |
|------------|---------------------|---------------|---------------|---------------|---------------|---------------|---------------|---------------|---------------|---------------|----------------------------------|------------------|------------------|------------------|
|            | 12" High Wall       | 15" High Wall | 18" High Wall | 21" High Wall | 24" High Wall | 27" High Wall | 30" High Wall | 36" High Wall | 39" High Wall | 42" High Wall | 84" High Utility or Vanity Linen | 90" High Utility | 93" High Utility | 96" High Utility |
| 12" Wide   |                     |               | ●             |               | ●             |               | ●             | ●             | ●             | ●             | ●                                | ●                | ●                | ●                |
| 13" Wide   |                     |               | ●             |               | ●             |               | ●             | ●             | ●             | ●             |                                  |                  |                  |                  |
| 15" Wide   | ◆                   | ●             | ●             | ●             | ●             | ●             | ●             | ●             | ●             | ●             | ●                                | ●                | ●                | ●                |
| 16" Wide   | ◆                   | ●             | ●             | ●             | ●             |               | ●             | ●             | ●             | ●             |                                  |                  |                  |                  |
| 18" Wide   | ◆                   | ●             | ●             | ●             | ●             |               | ●             | ●             | ●             | ●             | ●                                | ●                | ●                | ●                |
| 19" Wide   | ◆                   | ●             | ●             |               | ●             |               | ●             |               |               |               |                                  |                  |                  |                  |
| 21" Wide   |                     |               | ●             |               | ●             |               | ●             | ●             | ●             | ●             |                                  |                  |                  |                  |
| 30" Wide   |                     | ■             | ■             |               |               |               |               |               |               |               |                                  |                  |                  |                  |
| 36" Wide   |                     | ■             | ■             |               |               |               |               |               |               |               |                                  |                  |                  |                  |

- Available with all Specialty Door Options
- Wall Top Hinge cabinets only - not available with HFD, MFD or PFD Options
- ◆ HFD Option not available, PFD Option only available for Leesburg, Leesburg w/ DFO, or Shorebrook (excluding Duraform) door styles

## Specialty Door Availability by Door Style

| Door Style              | OFD | MFD | HFD | PFD | AF_ |
|-------------------------|-----|-----|-----|-----|-----|
| Ashland                 | ●   | ●   |     |     |     |
| Atherton                | ●   |     |     |     | ●   |
| Brookland               | ●   | ●   |     |     | ●   |
| Charlottesville         | ●   | ●   |     |     | ●   |
| Del Ray                 | ●   |     | ●   |     | ●   |
| Glen Ellen              | ●   |     |     |     |     |
| Hanover                 | ●   |     |     |     | ●   |
| Leesburg                | ●   | ●   | ●   | ●   | ●   |
| Leesburg w/ DFO         | ●   | ●   | ●   | ●   | ●   |
| MacArthur               | ●   |     |     |     | ●   |
| Newport                 | ●   | ●   |     |     |     |
| Olmsted                 | ●   | ●   |     |     |     |
| Portland                | ●   | ●   |     |     |     |
| Portola                 | ●   | ●   |     |     | ●   |
| Portola w/ DFO          | ●   | ●   |     |     | ●   |
| Reading                 | ●   | ●   | ●   | ●   | ●   |
| Reading w/ DFO          | ●   | ●   | ●   | ●   | ●   |
| Reading w/ DFO Duraform | ●   |     |     |     | ●   |
| San Mateo               | ●   |     |     |     |     |
| Savannah                | ●   | ●   |     |     | ●   |
| Shorebrook              | ●   | ●   | ●   | ●   | ●   |
| Shorebrook Duraform     | ●   | ●   |     |     | ●   |

**Open Frame Specialty Doors**

**OFD**

**Profiles for:**

- Ashland
- Charlottesville
- Newport
- Olmsted
- Portland
- Portola
- Portola w/ DFO

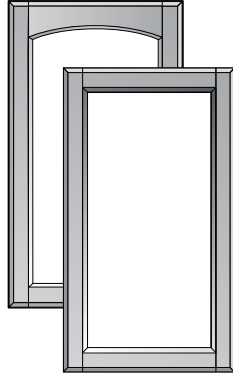

**Profile for:**

- Leesburg
- Leesburg w/ DFO
- San Mateo
- Shorebrook

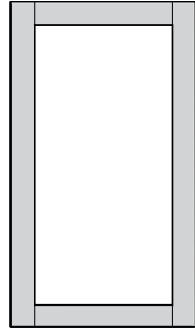

**Profile for:**

- Hanover
- Reading
- Reading w/ DFO

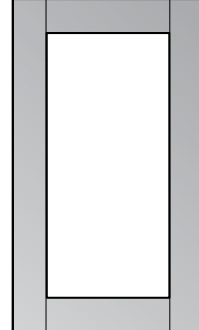

**Profile for:**

- Del Ray

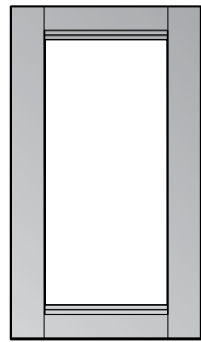

**Profile for:**

- Glen Ellen

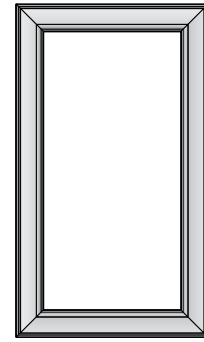

**Profile for:**

- Atherton

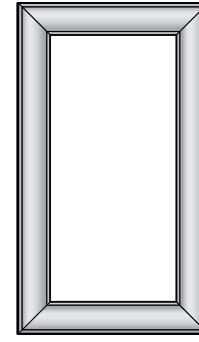

**Profile for:**

- Brookland

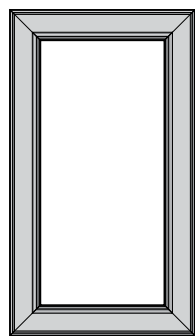

**Profile for:**

- Savannah

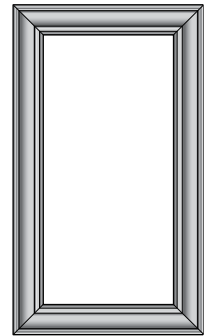

**Profile for:**

- MacArthur

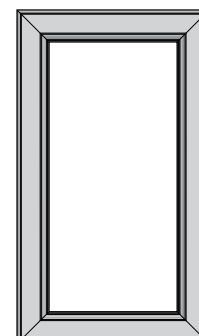

**Mullion Frame Specialty Doors**

**MFD**

**Profiles for:**

- Ashland
- Charlottesville
- Newport
- Olmsted
- Portland
- Portola
- Portola w/ DFO

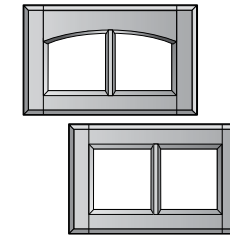

12" High Wall Cabinet

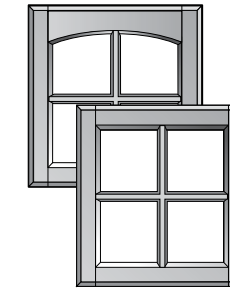

15", 18", 21",  
24" or 27"  
High Wall Cabinet

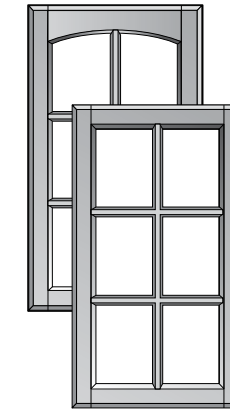

30" or 36" High Wall Cabinet  
84" or 90" High Utility Cabinet  
84" High Vanity Linen Cabinet

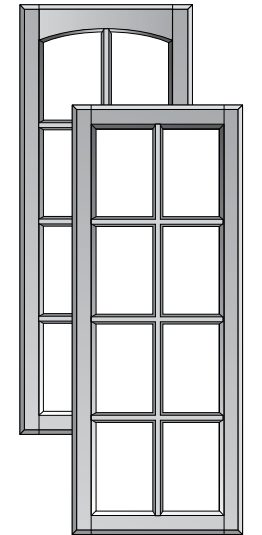

39" or 42" High Wall Cabinet  
93" or 96" High Utility Cabinet

**Profile for:**

- Leesburg
- Leesburg w/ DFO
- Shorebrook

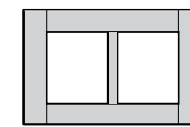

12" High Wall Cabinet

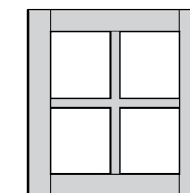

15", 18", 21",  
24" or 27"  
High Wall Cabinet

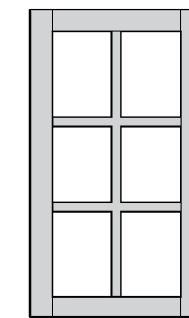

30" or 36" High Wall Cabinet  
84" or 90" High Utility Cabinet  
84" High Vanity Linen Cabinet

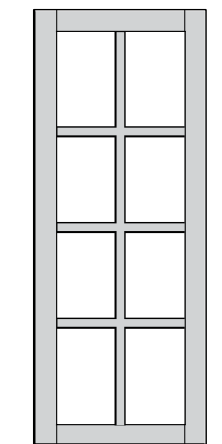

39" or 42" High Wall Cabinet  
93" or 96" High Utility Cabinet

**Mullion Frame Specialty Doors**

**MFD**

**Profile for:**

- Savannah

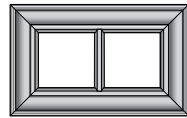

12" High Wall Cabinet

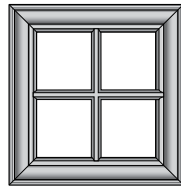

15", 18", 21",  
24" or 27"  
High Wall Cabinet

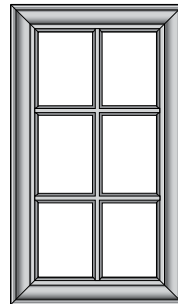

30" or 36" High Wall Cabinet  
84" or 90" High Utility Cabinet  
84" High Vanity Linen Cabinet

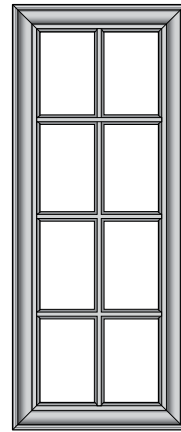

39" or 42" High Wall Cabinet  
93" or 96" High Utility Cabinet

**Profile for:**

- Brookland

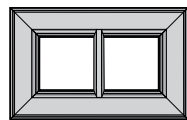

12" High Wall Cabinet

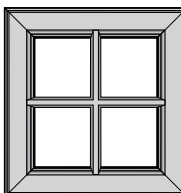

15", 18", 21",  
24" or 27"  
High Wall Cabinet

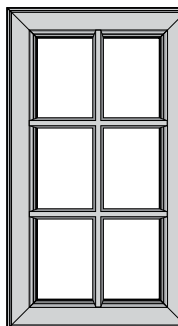

30" or 36" High Wall Cabinet  
84" or 90" High Utility Cabinet  
84" High Vanity Linen Cabinet

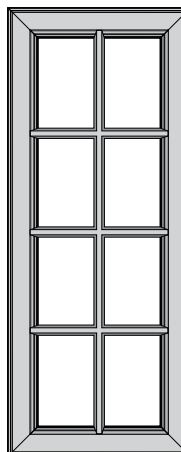

39" or 42" High Wall Cabinet  
93" or 96" High Utility Cabinet

**Mullion Frame Specialty Doors**

**MFD**

**Profile for:**

- Reading
- Reading w/ DFO\*

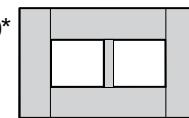

12" High Wall Cabinet

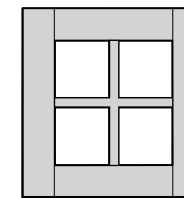

15", 18", 21",  
24" or 27"  
High Wall Cabinet

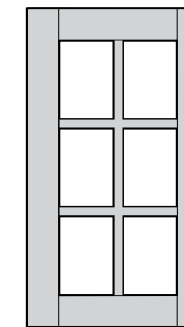

30" or 36" High Wall Cabinet  
84" or 90" High Utility Cabinet  
84" High Vanity Linen Cabinet

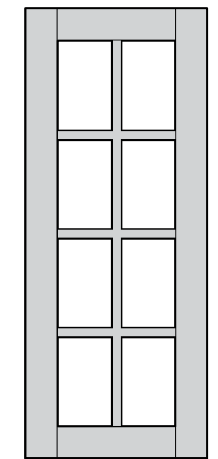

39" or 42" High Wall Cabinet  
93" or 96" High Utility Cabinet

\*Not available for Reading w/ DFO Duraform

**Prairie Frame Specialty Doors**

**PFD**

**Profile for:**

- Leesburg
- Leesburg w/ DFO
- Shorebrook\*

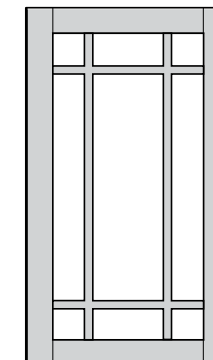

\*Not available for Shorebrook Duraform

**Profile for\*:**

- Reading
- Reading w/ DFO†

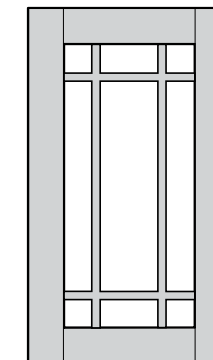

\*PFD option not available for 12" High Wall Cabinets

†Not available for Reading w/ DFO Duraform



**Horizontal Frame Specialty Doors**

**HFD**

**Profile for:**

- Leesburg
- Leesburg w/ DFO
- Shorebrook\*

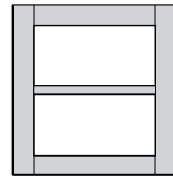

15", 18", 21",  
24" or 27"  
High Wall Cabinet

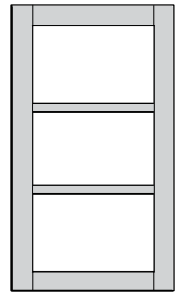

30" or 36" High Wall Cabinet  
84" or 90" High Utility Cabinet  
84" High Vanity Linen Cabinet

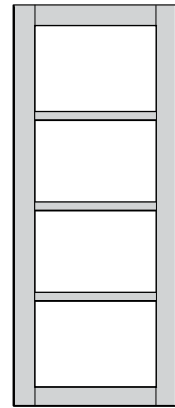

39" or 42" High Wall Cabinet  
93" or 96" High Utility Cabinet

\*Not available for Shorebrook Duraform

**Profile for:**

- Reading
- Reading w/ DFO\*

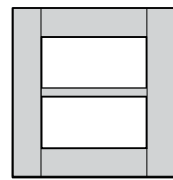

15", 18", 21",  
24" or 27"  
High Wall Cabinet

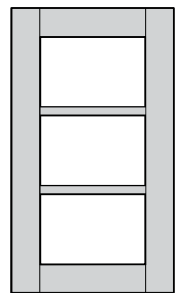

30" or 36" High Wall Cabinet  
84" or 90" High Utility Cabinet  
84" High Vanity Linen Cabinet

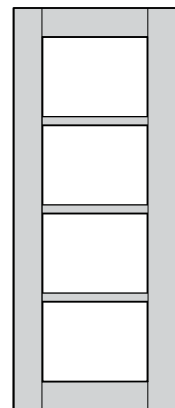

39" or 42" High Wall Cabinet  
93" or 96" High Utility Cabinet

\*Not available for Reading w/ DFO Duraform

**Profile for:**

- Del Ray

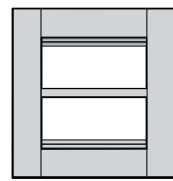

15", 18", 21",  
24" or 27"  
High Wall Cabinet

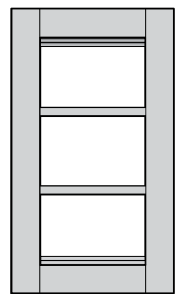

30" or 36" High Wall Cabinet  
84" or 90" High Utility Cabinet  
84" High Vanity Linen Cabinet

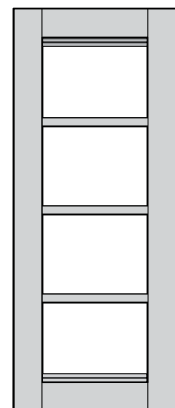

39" or 42" High Wall Cabinet  
93" or 96" High Utility Cabinet

**Aluminum Frame Specialty Doors - Brushed Aluminum**

**AFBA**

**Profile for:**

- Atherton
- Brookland
- Charlottesville
- Del Ray
- Hanover
- Leesburg
- Leesburg w/ DFO
- MacArthur
- Portola
- Portola w/ DFO
- Reading
- Reading w/ DFO
- Savannah
- Shorebrook

Brushed Aluminum  
with Frosted Glass



AFBA Frosted

Brushed Aluminum  
with Frosted Ash Glass



AFBA Frosted Ash

Brushed Aluminum  
with Woven Glass



AFBA Woven

**Aluminum Frame Specialty Doors - Vintage Iron**

**AFVI**

**Profile for:**

- Atherton
- Brookland
- Charlottesville
- Del Ray
- Hanover
- Leesburg
- Leesburg w/ DFO
- MacArthur
- Portola
- Portola w/ DFO
- Reading
- Reading w/ DFO
- Savannah
- Shorebrook

Vintage Iron with  
Frosted Glass



AFVI Frosted

Vintage Iron with  
Frosted Umber Glass



AFVI Frosted Umber

Vintage Iron with  
Havana Glass



AFVI Havana

**Afton Glass**

**Antiqued Afton Glass**



**Clear Glass**



OFD

- 5/16" overall thickness
- Afton has a clear glass design using zinc coming with clear beveled diamonds
- Antiqued Afton has a clear glass design using bronze patina coming with clear beveled diamonds
- Features one row of diamonds for 12"-18" high doors and two rows for 21" or higher doors
- Full Overlay (excluding 2 1/4" stiles and rails) and Partial Overlay door styles feature one column of diamonds for 12"-15" wide doors and two columns for 16" or wider doors
- Full Overlay door styles with 2 1/4" stiles and rails feature one column of diamonds for 12"-13" wide doors and two columns for 15" or wider doors
- Includes appropriate Decorative Glass Clips
- Not available for Wall Top Hinge cabinets
- Order as DGI-\_\_AFTON or ANTIQUED AFTON, refer to Parts Directory for nomenclature and dimensions

HFD  
MFD  
OFD  
PFD

- 1/8" thick panel
- Clear glass
- Tempered safety glass
- Includes appropriate Decorative Glass Clips
- Order as DGI-\_\_CLEAR, refer to Parts Directory for nomenclature and dimensions

HFD  
MFD  
OFD  
PFD

**Frosted Glass**



**Frosted Ash Glass**



**Frosted Umber Glass**



- 1/8" thick panel
- Frosted glass with etched finish
- Tempered safety glass
- Includes appropriate Decorative Glass Clips
- Order as DGI-\_\_FROSTED, refer to Parts Directory for nomenclature and dimensions

HFD  
MFD  
OFD  
PFD

- 1/8" thick panel
- Gray tinted glass
- Tint is manufactured in material - not a film
- Tempered safety glass
- Includes appropriate Decorative Glass Clips
- Order as DGI-\_\_FROSTED ASH, refer to Parts Directory for nomenclature and dimensions

HFD  
MFD  
OFD  
PFD

- 1/8" thick panel
- Bronze tinted glass
- Tint is manufactured in material - not a film
- Tempered safety glass
- Includes appropriate Decorative Glass Clips
- Order as DGI-\_\_FROSTED UMBER, refer to Parts Directory for nomenclature and dimensions

**Fincastle Glass**

**Antiqued Fincastle Glass**



**Derbyshire Seeded Glass**



OFD

- 5/16" overall thickness
- Fincastle has a clear glass design using zinc coming
- Antiqued Fincastle has a clear glass design using bronze patina coming
- Not available for 12" high doors
- Includes appropriate Decorative Glass Clips
- Not available for Wall Top Hinge cabinets
- All sizes features 3 vertical coming lines, spacing will vary according to glass width
- Order as DGI-\_\_FINCASTLE or ANTIQUED FINCASTLE, refer to Parts Directory for nomenclature and dimensions

HFD  
MFD  
OFD  
PFD

- 5/16" thick panel
- Clear seeded glass
- Laminated safety glass
- Includes appropriate Decorative Glass Clips
- Order as DGI-\_\_DERBYSHIRE, refer to Parts Directory for nomenclature and dimensions

HFD  
MFD  
OFD  
PFD

**Havana Glass**



**Impression Glass**



**Lucent Glass**



- 1/8" thick panel
- Bronze tinted glass with a two-sided acid etched pattern - one horizontal and one vertical
- Tempered safety glass
- Includes appropriate Decorative Glass Clips
- Order as DGI-\_\_HAVANA, refer to Parts Directory for nomenclature and dimensions

HFD  
MFD  
OFD  
PFD

- 1/8" thick panel
- Sculptural glass
- Tempered safety glass
- Includes appropriate Decorative Glass Clips
- Order as DGI-\_\_IMPRESSION, refer to Parts Directory for nomenclature and dimensions

HFD  
MFD  
OFD  
PFD

- 1/8" thick panel
- Sculptural glass
- Tempered safety glass
- Includes appropriate Decorative Glass Clips
- Order as DGI-\_\_LUCENT, refer to Parts Directory for nomenclature and dimensions

**Meredith Glass**



OFD

- 1/4" overall thickness (1/8" beveled edge thickness)
- Clear glass design with 1 1/4" wide beveled edges
- Tempered safety glass
- Includes appropriate Decorative Glass Clips
- Order as DGI-\_\_MEREDITH, refer to Parts Directory for nomenclature and dimensions

**Mirror Glass**



HFD  
MFD  
OFD  
PFD

- 1/4" thick panel
- Laminated safety glass
- White vinyl in between glass layers
- Includes appropriate Decorative Glass Clips
- Order as DGI-\_\_MIRROR, refer to Parts Directory for nomenclature and dimensions

**Radiance Glass**



HFD  
MFD  
OFD  
PFD

- 1/4" thick panel
- Clear glass with randomized bronze/copper fabric
- Randomized patterns may result in inherent variations between adjacent pieces
- Laminated safety glass
- Includes appropriate Decorative Glass Clips
- Order as DGI-\_\_RADIANCE, refer to Parts Directory for nomenclature and dimensions

**Ribbed Glass**



HFD  
MFD  
OFD  
PFD

- 1/8" thick panel
- Clear ribbed glass
- Tempered safety glass
- Includes appropriate Decorative Glass Clips
- Not available for Wall Top Hinge cabinets
- Order as DGI-\_\_RIBBED, refer to Parts Directory for nomenclature and dimensions

**Twilight Glass**



HFD  
MFD  
OFD  
PFD

- 1/4" thick panel
- Laminated safety glass
- Clear glass with randomized silver fabric
- Randomized patterns may result in inherent variations between adjacent pieces
- Includes appropriate Decorative Glass Clips
- Order as DGI-\_\_TWILIGHT, refer to Parts Directory for nomenclature and dimensions

**Woven Glass**



HFD  
MFD  
OFD  
PFD

- 1/8" thick panel
- Acid-etched fabric pattern
- Low-iron glass
- Tempered safety glass
- Includes appropriate Decorative Glass Clips
- Order as DGI-\_\_WOVEN, refer to Parts Directory for nomenclature and dimensions

**Prepped for Glass**

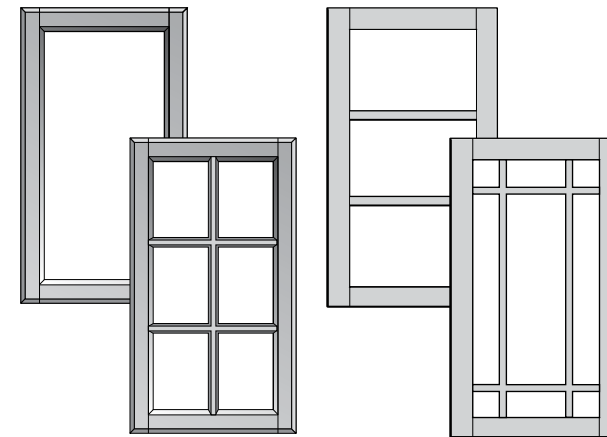

HFD  
MFD  
OFD  
PFD

- For customer installed inserts up to 3/16" thick
- Refer to pages 64-68 for door style specific profile
- Decorative Glass Clips not included - order separately

**Decorative Glass Clips**

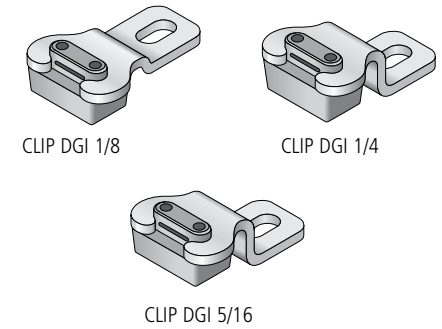

CLIP DGI 1/8  
CLIP DGI 1/4  
CLIP DGI 5/16

- For installation of Decorative Glass Inserts
- Order one bag (six clips) per door
- See chart below for correct glass pairing

| Glass Insert       | CLIP DGI 1/8 | CLIP DGI 1/4 | CLIP DGI 5/16 |
|--------------------|--------------|--------------|---------------|
| Afton              |              |              | •             |
| Antiqued Afton     |              |              | •             |
| Antiqued Fincastle |              |              | •             |
| Clear              | •            |              |               |
| Derbyshire         |              |              | •             |
| Fincastle          |              |              | •             |
| Frosted            | •            |              |               |
| Frosted Ash        | •            |              |               |
| Frosted Umber      | •            |              |               |
| Havana             | •            |              |               |
| Impression         | •            |              |               |
| Lucent             | •            |              |               |
| Meredith           | •            |              |               |
| Mirror             |              | •            |               |
| Radiance           |              | •            |               |
| Ribbed             | •            |              |               |
| Twilight           |              | •            |               |
| Woven              | •            |              |               |